

400 Middle Street, Suite J • Bristol, CT 06010-8405

### GETTING STARTED / INSTALLING TIPS

**IMPORTANT!** Read all instructions carefully and completely to ensure proper installation.

**WARNING!** Parts have sharp points & edges. Use extreme caution when handling & installing. Wear safety glasses at all times.

#### Tools & Materials Needed



Safety Glasses



Power screw gun with ratcheting torque setting



Biscuit Router (optional)

**Step 1**

#### INSTALLING THE FIRST BOARD.

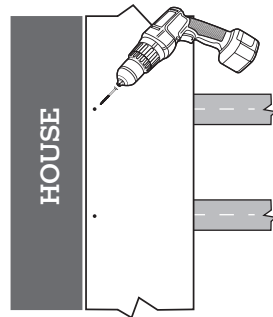

Fasten outer edge of the first board at each framing support. It is important that this board is straight and well secured.

**Step 3**

#### INSTALL FIRST FASTENER.

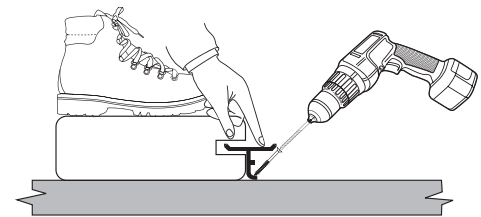

While standing on deck board, install provided screw at 45° angle through fastener and into joist, while applying pressure on fastener. Install one fastener and screw at each support joist.

**Make sure fastener body is vertical to deck board and the screw is holding fastener down tight to deck board.**

**Step 2**

#### POSITION FASTENERS.

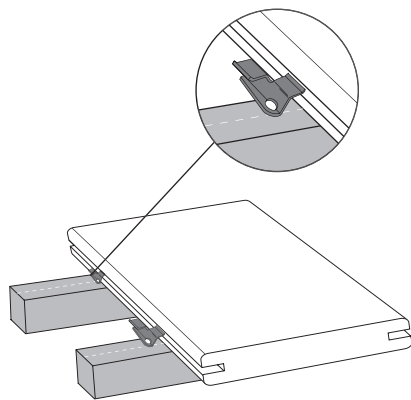

Fully insert TC-G fastener into grooved edge of deck board. Screw hole should be lined up with the center of support joist.

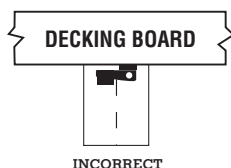

INCORRECT

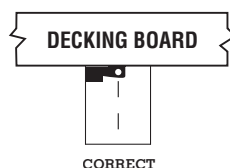

CORRECT

**Step 4**

#### COMPLETING INSTALLATION OF BOARD.

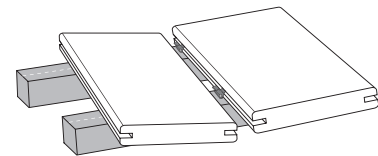

**a** Place next deck board into position against fasteners. Slightly raise outer edge of board being installed and slide board onto fastener until board contacts spacer tab.

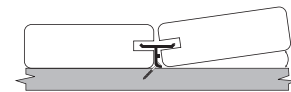
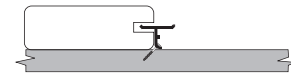

**PROPER GAPPING**  $\frac{3}{16}$

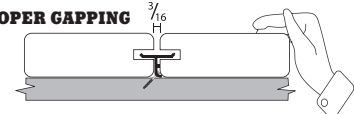

**b** Check gap between boards for consistency. Apply force to ensure board is fully installed.

**Repeat steps 2 thru 4 until deck is complete.**

# Tiger Claw®

## Hidden Deck Fasteners

### HELPFUL TIPS

#### What tools are required?

No special tools are required when using pre-grooved deck boards, just a drill with screwdriver tip. When using decking without the grooved edge, a biscuit router will be needed to create a groove at each joist.

#### Coverage

- a** Multiply the number of joists by the number of decking boards to equal the number of fasteners needed.
- b** 90 fasteners will cover approximately 50 sq. ft. (using 5.5" decking boards on 16" centers).

#### 45° angle installation

**Where deck is in the walled corner of the house:** always start with small triangular piece of decking in that corner and work your way out. When installing TC Fasteners, offset the center 1/2" towards the long point of joist, so screw will not exit side of joist when driven.

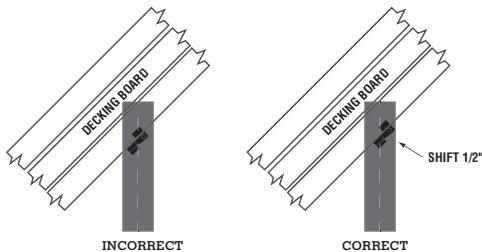

#### How to do a butt seam

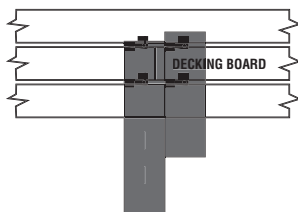

First, install a small framing board (10 – 12") alongside the joist in which the seam is going to land. Install additional fastener into previous board above small framing block. Line up your first board in the center of the joist and the small framing board. Install fasteners and screws at each joist of the first board including the joist at the seam. Then install your second board in the same fashion, and place a second fastener at the seam attaching it to the small framing block. Make sure you pay attention to end-to-end gapping specifications.

#### How do you attach the last board?

To finish, we recommend using either finishing nails or trim screws to secure the last board along its edge or under a rail. Also, you can angle a screw through the deck frame and into the bottom of the deck board.

#### How to replace a board

- a** Make two parallel cuts down the center of the board to be replaced, and remove the center piece.
- b** Using a small pry bar, remove the remaining pieces of decking from the tabs.
- c** Using a reciprocating saw, remove the tabs on the side of the board with the screw heads showing.
- d** Position new board into place, and carefully drive onto remaining tabs.
- e** Once board is set into position, secure the lead edge with finish nail, finish screw, or counter drill, screw and plug.

#### To use the TC-G fastener on unslotted boards:

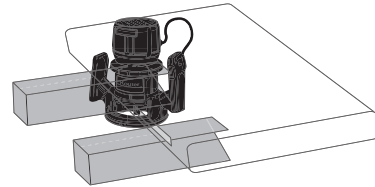

- a** Use a biscuit router to create a groove at every intersection of the deck board and support joists.

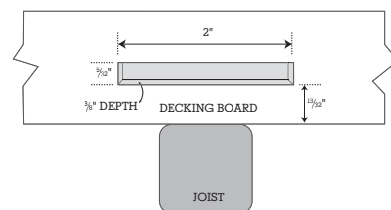

- b** A router with a 5/32" slot cutting bit\* can be used to groove the entire edge of the board. \*(Freud model # 63-109 or similar)

**NOTE:** The groove should start 13/32" (slightly greater than 3/8") above the **BOTTOM** of the deck board. Groove should be at least 7/16" deep.

**NOTE:** When using material with expected expansion greater than 1/8", allow additional spacing between deck boards. (Check with your lumber supplier for expected expansion in your area).

**Remember: Tiger Claw has a fastener for all your decking needs.**

**TC-2 Softwood Deck Fastener:**  
Pressure-Treated, Cedar and Redwood

**TC-3 Composite Deck Fastener:**  
Composite or Medium Density Hardwoods

**TC-4 Hardwood Deck Fastener:**  
Exotic Hardwoods

**TC-P Cellular PVC Deck Fastener:**  
For Cellular PVC Decking Materials